

□ S055-6Y

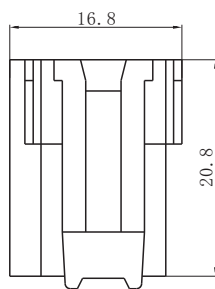
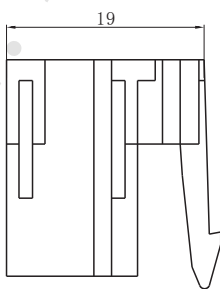

Material (材料)

Housing (胶壳): Nylon (尼龙) UL94-V0 (2)

符合RoHS标准
RoHS compliance

□ S055-3S

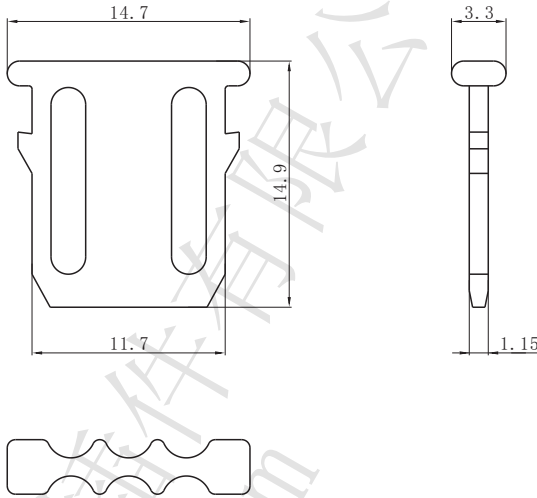

Material (材料)

Housing (胶壳): Nylon (尼龙) UL94-V0 (2)

符合RoHS标准
RoHS compliance